

Quick•Tower

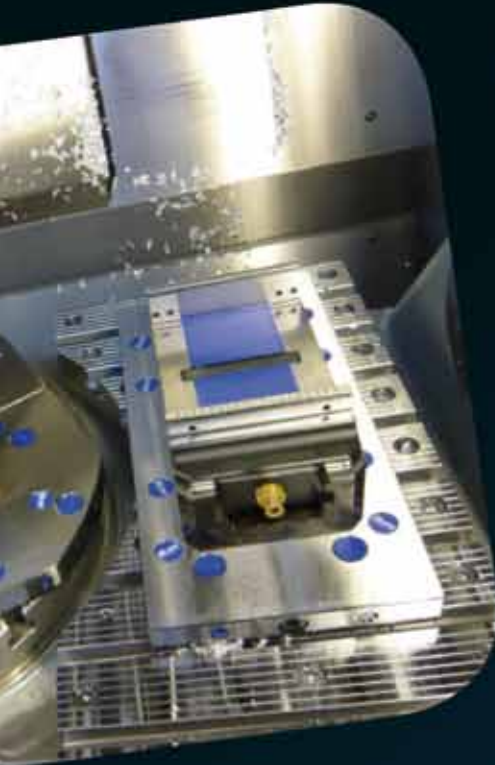

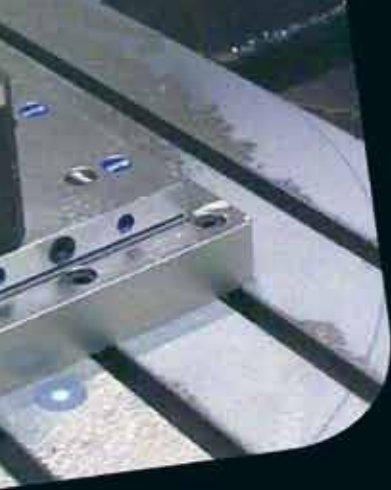

Quick•Tower
Base body
page 123

Quick•Point®
Zero-point plates
page 124

Quick•Tower – The clamping system for horizontal machines

Quick•Point® plates
52mm and 96mm
can be attached

Continuous
zero-point grid

4x90°

Compatible with
all of LANG's
workholding devices

Stable, sturdy
cast body

Mounting to the machine tool table
via clamping studs (serially) or mounting
bores (individually on customer's request)

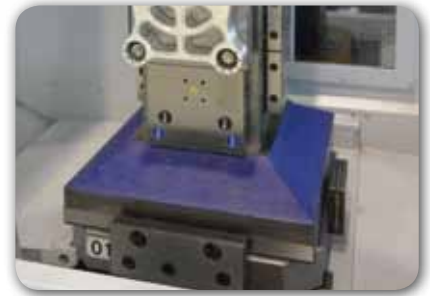
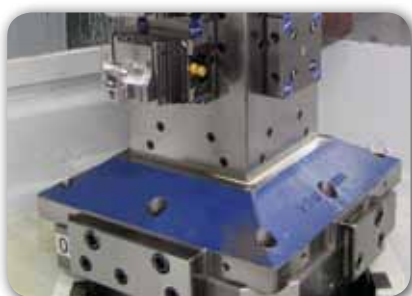
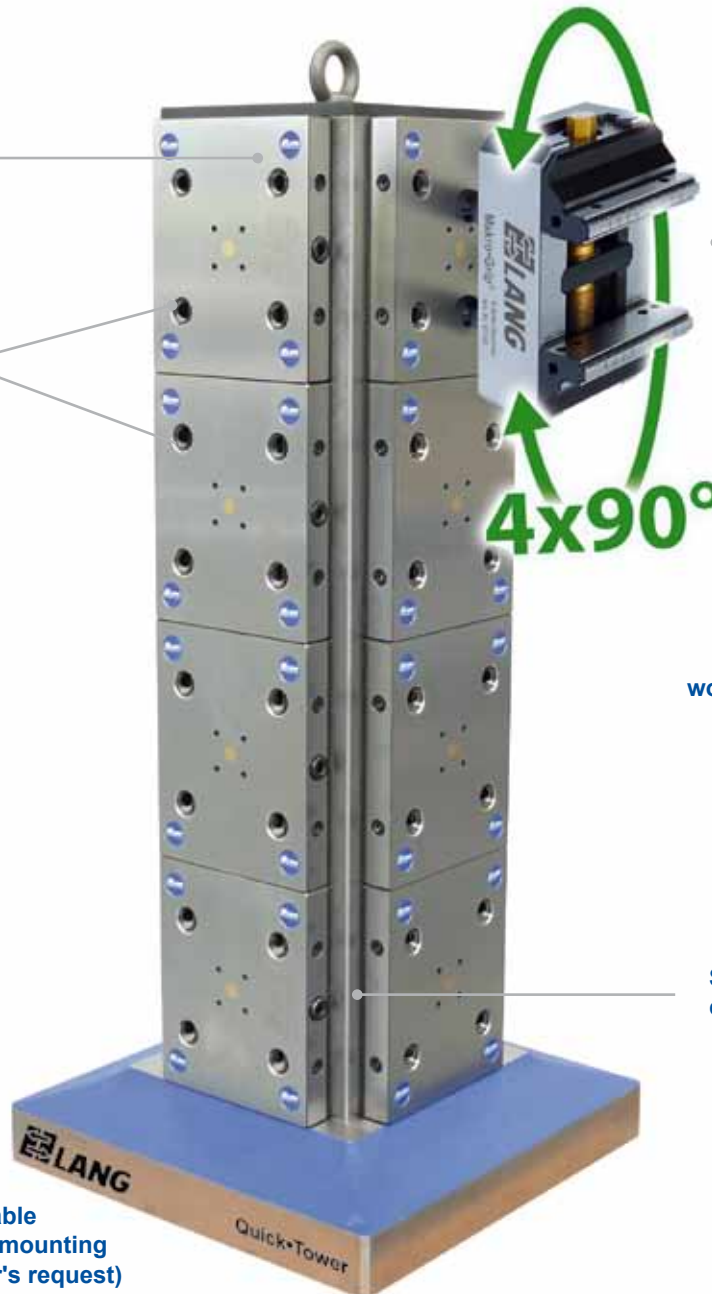

Alternatively an individual hole pattern according to customer's requests can be inserted to mount the tower directly on the machine table.

12 Quick•Point® clamping studs are included as standard – For quick and accurate adaptation of the tower to 4 grid plates (item # 45710)

Self-made fixtures can be clamped with clamping studs

- ✓ Low vibrations due to stable cast body
- ✓ Machine running time can be increased by multiple clamping
- ✓ Workpiece in clamping device can be rotated quickly and precisely by 90 degrees
- ✓ Instead of 3 sides, 5 sides can be machined
- ✓ Individual set-up of tombstone using Quick•Point® plates
- ✓ Quick and uncomplicated change-over of various clamping fixtures



Various applications of Quick•Tower for single and serial parts

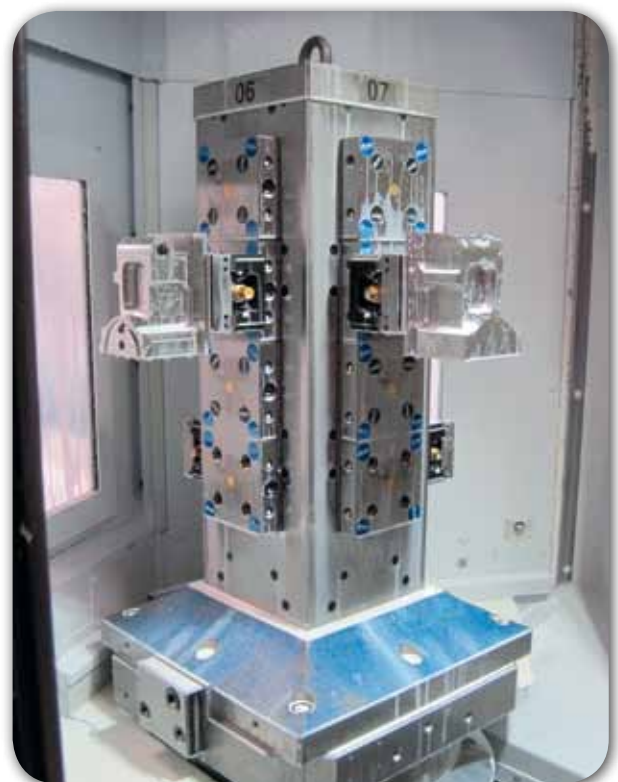

Simple mounting to machine table



Alternatively an individual hole pattern according to customer's request can be inserted to mount the tower directly on the machine table.



12 Quick•Point® clamping studs are included as standard - For quick and accurate adaptation of the tower to 4 grid pallets (45710).

Quick•Tower base body

Precise machined surface with plane parallelism of ± 0.02 mm on total height

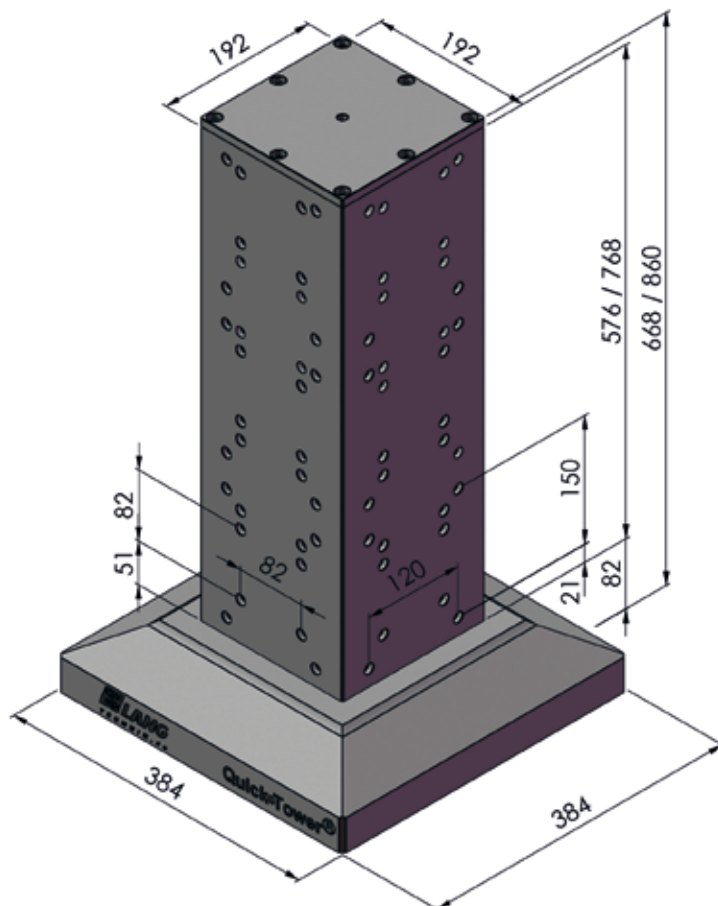

Grip of 150 x 120 mm is designed to mount Quick•Point® pallets 75710.

Grip 82 x 82 mm is designed to mount Quick•Point® pallets 75600

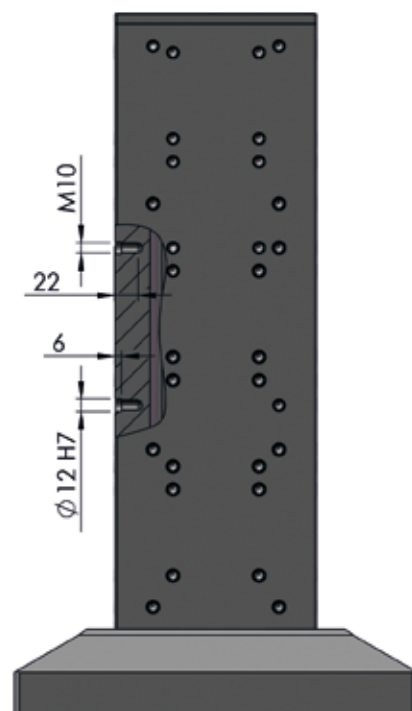

Quick•Tower base body				
Description/Type	Total height in mm	Weight in kg	Order No.	Price
Quick•Point® base body 650 Body: <input type="checkbox"/> 192 x 192 mm Base: <input type="checkbox"/> 384 x 384 mm	668	130	70650	
Quick•Point® base body 850 Body: <input type="checkbox"/> 192 x 192 mm Base: <input type="checkbox"/> 384 x 384 mm	860	160	70850	
Individual mounting hole pattern on customer's request	-	-	70004	

13x 52 mm grid on every side

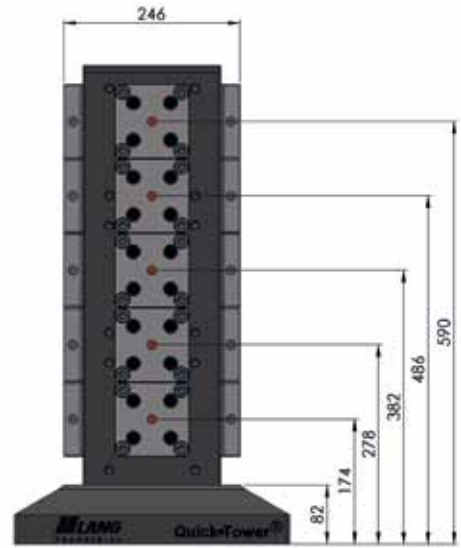
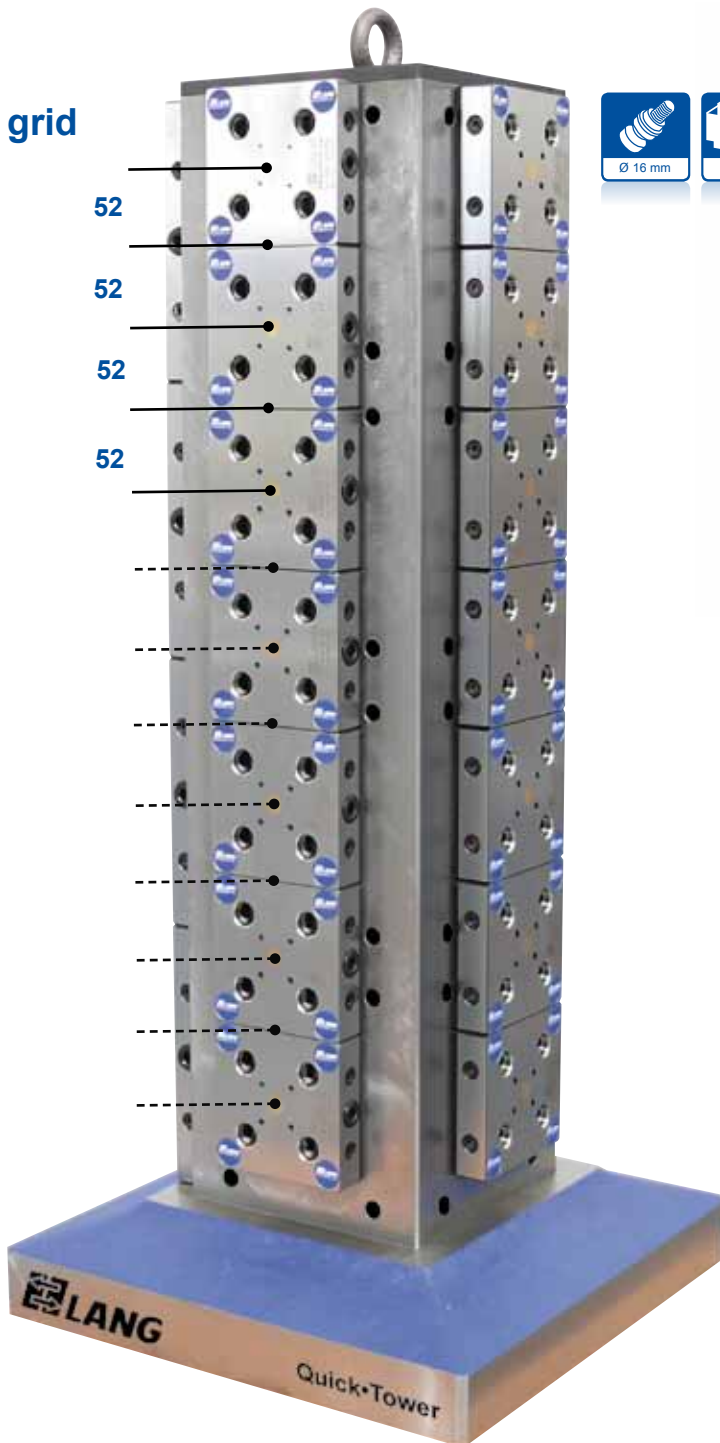

Tower 70650, height 668
max. 5 pallets on each side

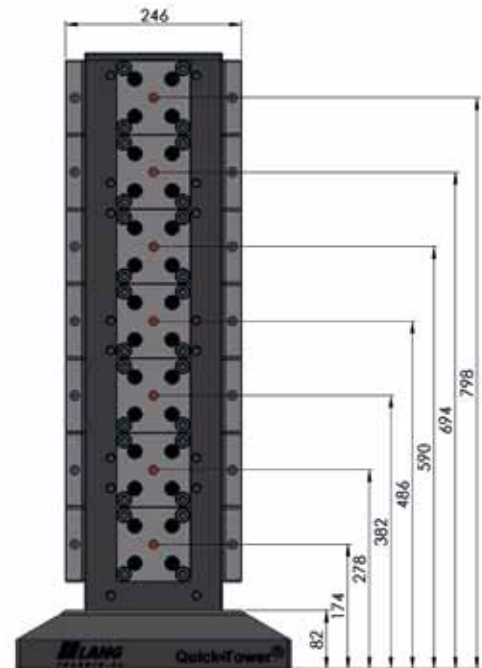

Tower 70850, height 860
max. 7 pallets on each side



Quick-Point® 52					
Description/Type	Dimension in mm	Weight in kg	Order No.	Amount	Price per piece
Quick-Point® 52 mm stud distance	104 x 104 Height: 27	1,8	75600	up to 15	
				16 to 49	
				from 50	

*Block pricing only applies for a purchase of Quick-Tower

7x 96 mm grid on every side

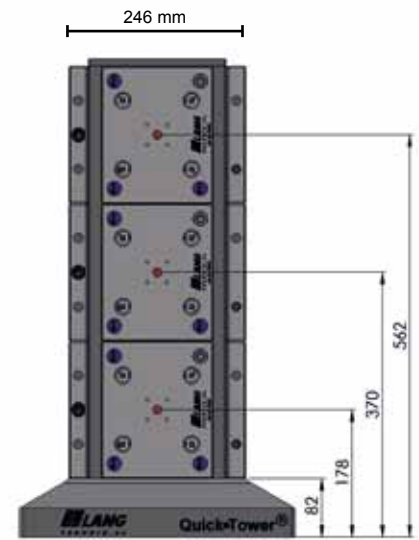
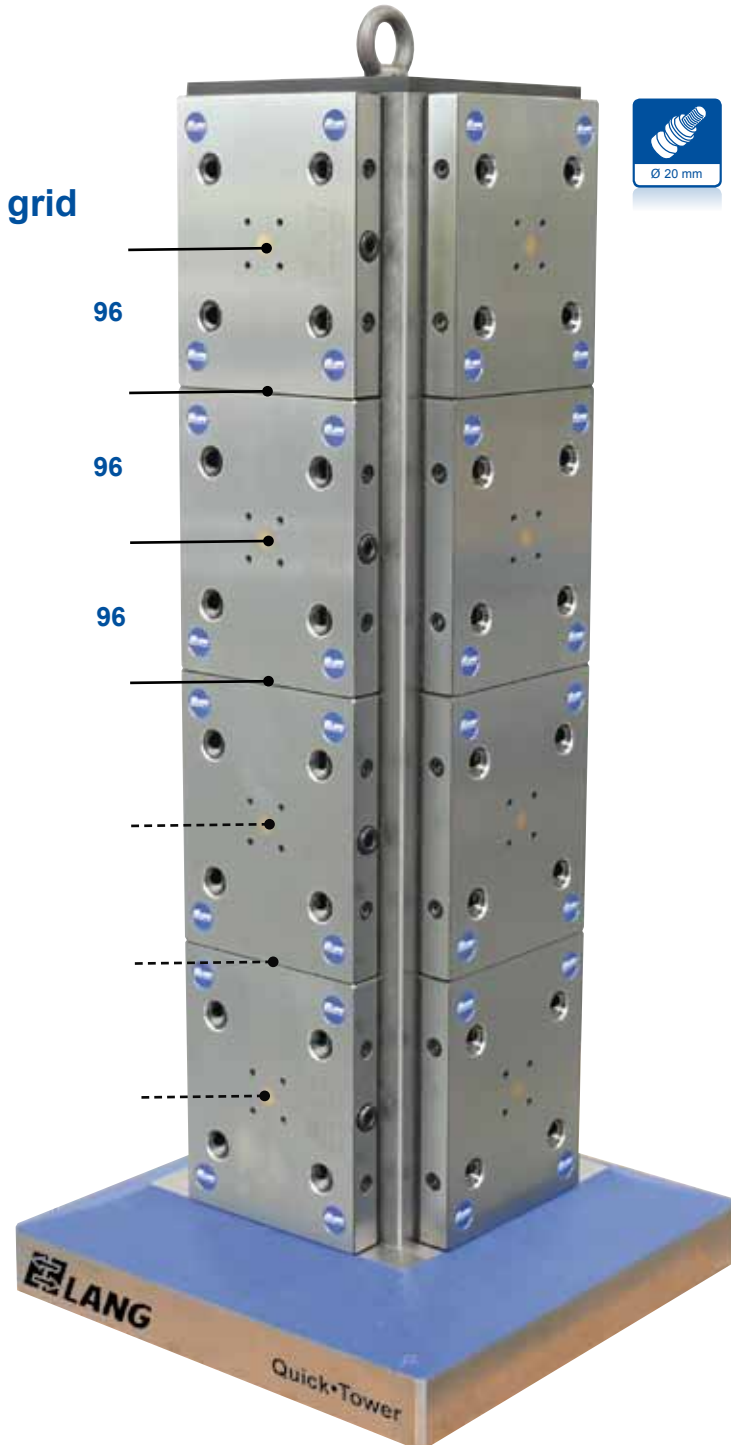

Tower 70650, height 668
max. 3 pallets on each side

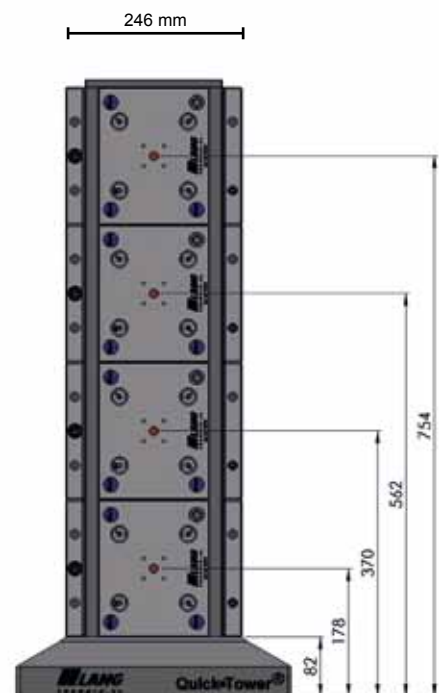

Tower 70850, height 860
max. 4 pallets on each side



Quick•Point® 96					
Description/ Type	Dimension in mm	Weight in kg	Order No.	Amount	Price per piece
Quick•Point® 96 mm stud distance	192 x 192 Height: 27	5,8	75710	up to 10	
				11 tp 29	
				from 30	

*Block pricing only applies for a purchase of Quick•Tower